

Operation Manual



Caresaver Universal Refrigerant Recovery Unit

CONTENTS

CHAPTER 1

INTRODUCTION AND OVERVIEW

Specifications	3
Health and Safety	4-5
Component Location and Identification	6-9

CHAPTER 2

OPERATION

Operation	10
Refrigerant Recovery Pass Through Setup	10
Refrigerant Recovery Push-Pull Setup	11
Hints and Tips	12-13

CHAPTER 3

MAINTENANCE

Routine	14
---------	----

CHAPTER 4

TROUBLESHOOTING

Unit will not start	15
Recovery slows down	15
High Pressure trip	15

CHAPTER 5

APPENDICES

Piping and Instrumentation Diagram	17
Wiring Schematic	18
Spare Parts List	19

CHAPTER 1

INTRODUCTION & OVERVIEW

The CARESAVER Universal Refrigerant Recovery Units are designed as compact, easy to use service tools for use in dry locations. The units will remove refrigerants in liquid or vapour state from the plant direct to a suitable recovery cylinder.

Specifications:

Refrigerants	R22, R134a, R404a, R407c, R410a, R413a, R417a, R502, R600a, R290, R32, R441a, R1234yf, R1270 and CARE® refrigerants
Applications	Domestic, Commercial, Air Conditioning, Automotive
Power Options	230V 1ph 50Hz, 110v 1ph 50Hz
Compressor	Hermetic oil-lubricated, Air cooled
Power Absorbed	145W
Run Current	1.3A at 230vac
Operating Ambient Temperature	0°C to + 35°C
Recovery Capacity up to	70 lb/h (32 kg/h)
Protection	High Pressure switch, Thermal Overload
Max PS	190 psi (13bar) inlet, 360 psi (25bar) discharge
Connections	¼" SAE male flare
Size (Length x Width x Height)	18.5" x 9.25" x 13.18" (470 x 235 x 335 mm)
Weight	46 lbs (21kg)

Health & Safety

Safety



This symbol is intended to alert the user to the presence of important operating, safety and maintenance instruction within this document. It will be used in this document to draw your attention to critical items.

Every effort has been made to make the unit as easy and safe to operate as possible but operators should always follow these safety precautions:

- Always wear appropriate eye protection, clothing and gloves when handling refrigerant.
- Only a trained operator should handle refrigerants, it is very important that you understand thoroughly the expansion & compression properties of the refrigerant. Never overfill a cylinder. Fill only to 60% of the volume with liquid to leave room for expansion.
- Do not use disposable refrigerant cylinders. This is very dangerous and could result in serious injury if the cylinder ruptures. Use only approved dual port dual valve recovery cylinders.
- Make sure that the plant is electrically isolated before attempting to transfer refrigerant.
- Do not leave the unit unattended whilst recovery is in progress.
- Read MSDS (Material Safety Data Sheets) for the refrigerant being recovered.



WARNING Refrigerant

Refrigerant under pressure poses a risk to life in respect of;

- Asphyxiation
- Severe Cardio-Vascular Impairment leading to heart failure
- Toxicity
- Damage to skin / eyes exposed to pressurised leak.
- By products of combustion if vapour contacts exposed flame or heat source.
- This unit should only be operated in a well ventilated area



Danger Electric shock risk

If it is required to remove the cover the power control switch should be switched off & the mains lead disconnected from the electrical mains supply.



Danger High pressure release

Be aware at all times when connecting implementing any maintenance on the unit that the presence of a high-pressure release could take place. Take sensible precautions to avoid this risk and use only the recommended ball valve hoses.



Danger to operate in wet conditions

This unit should not be operated in wet conditions.



Danger to operate in an Explosive Atmosphere

This unit should not be operated in an explosive atmosphere. Operate only in a well ventilated area provided with at least 4 air changes per hour or the unit should be located at least 46cms (18”) above the floor.



Risk of Fire

The unit is provided with a 5m (16ft) hard wired mains lead such that it can be plugged in outside of the work zone. To reduce the risk of fire when using extension cord it must be at least 2mm diameter (12AWG), fully unwound and not longer than 5m (16ft).



Responsibility

This unit must only be operated by operators who have had the correct training in refrigerant handling.



Legislation

WARNING UK Environmental Protection Act 1990

Deliberate release of the Refrigerant Charge to atmosphere is an offence and threatens the Environment.

Recovered Refrigerant is classed as Hazardous Waste.

Component Location & Identification

Front View

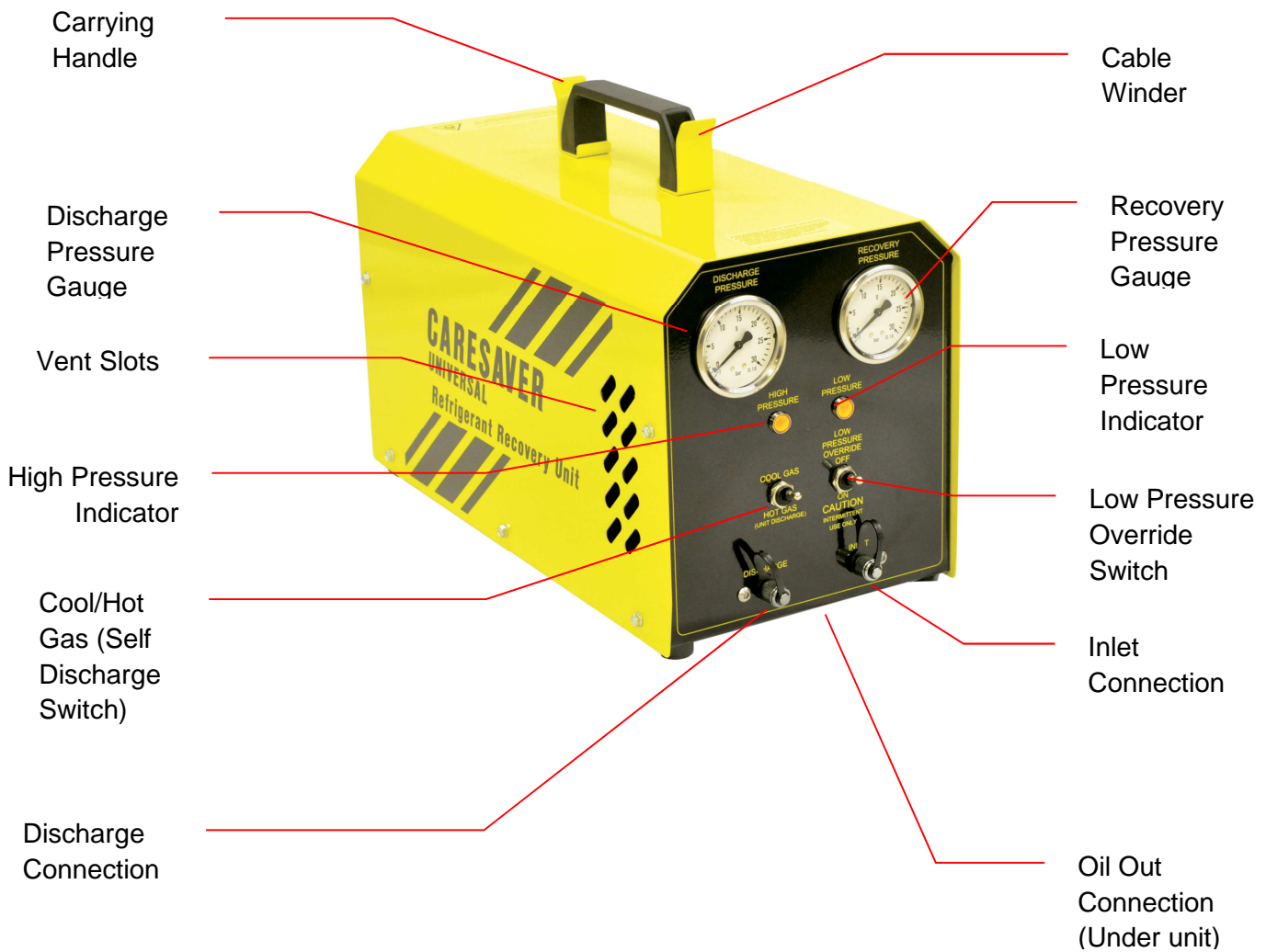

Rear View

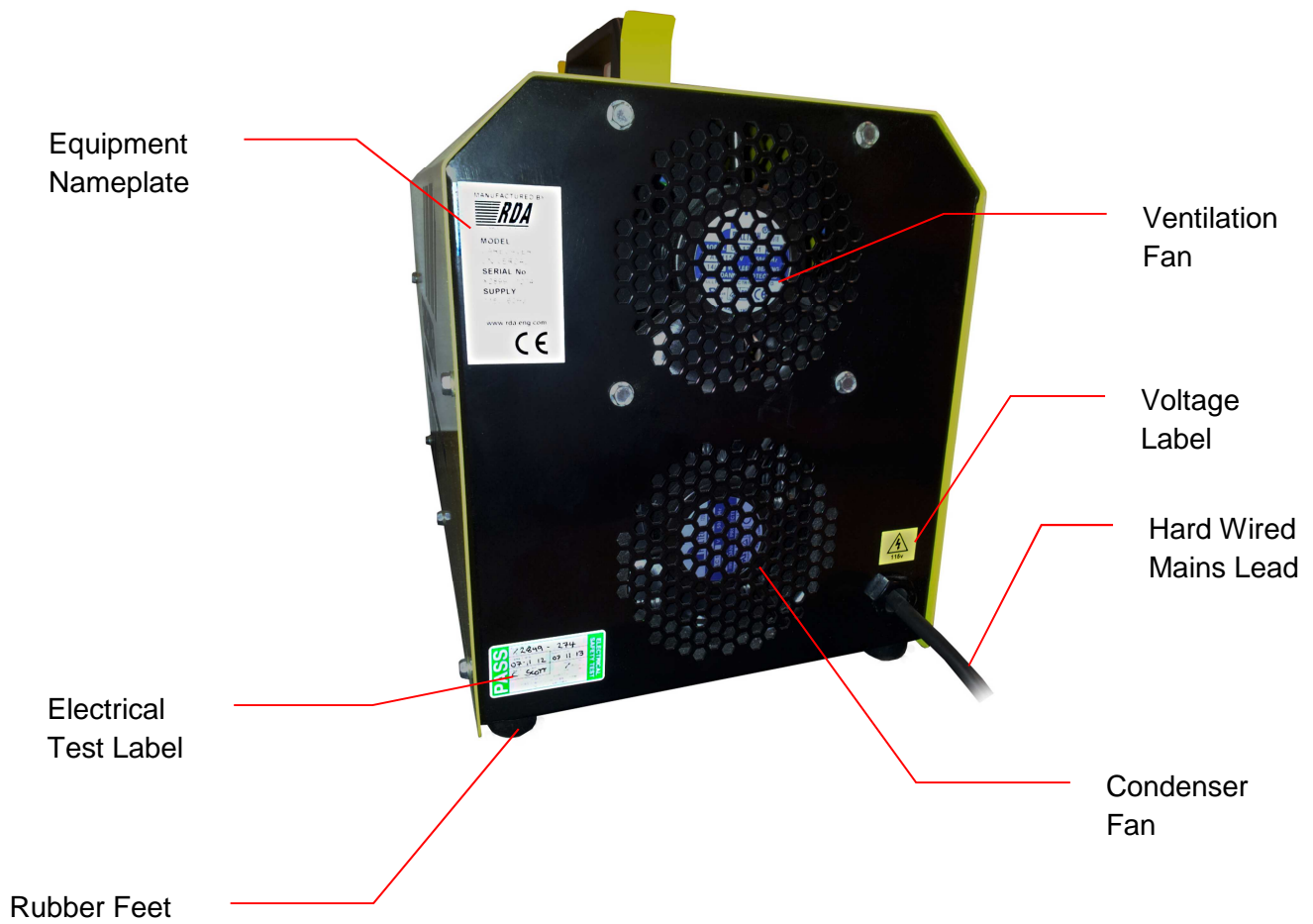

Component Identification:

Front View

HIGH PRESSURE INDICATOR - Indicates that the refrigerant discharge pressure is above 360 psi (25 bar) and the compressor is inhibited from running. Will extinguish when the pressure falls below 290psi (20 bar).

LOW PRESSURE INDICATOR - Indicates that the refrigerant suction pressure is below 9" mercury (-0.3 bar), the compressor is inhibited from running. Will extinguish when pressure rises above 17.4 psi (1.2 bar).

RECOVERY PRESSURE GAUGE – Indicates the pressure at the unit inlet. This is the pressure in the plant or equipment being serviced. The gauge is a safety pattern CL1.6 compound pressure gauge graduated either in bar interval between –1 to 30 bar or 30" mercury to 430psi graduated in 10psi interval.

DISCHARGE PRESSURE GAUGE – Indicates the pressure at the outlet of the unit. This is the same as the pressure in the recovery cylinder. The gauge is a safety pattern CL1.6 pressure gauge graduated in either bar interval between –1 to 30 bar or 30" mercury to 430psi graduated in 10psi interval.

LOW PRESSURE OVERRIDE SWITCH – In the up 'OFF' position the unit operates automatically and will stop pumping when the pressure is below 9" mercury (–0.3 bar). The down 'OVERRIDE' position enables the unit to continue to operate for a further 2 minutes as required for example when using piercing pliers.

COOL GAS/HOT GAS (SELF DISCHARGE) SWITCH - In the normal Cool Gas position the discharge from the compressor is routed through the air-cooled condenser. The Hot Gas and Self Discharge position is used to either pump high pressure vapour into the plant for Push-Pull recovery or with the inlet hose shut to discharge residual refrigerant in the unit.

INLET CONNECTION – 1/4" SAE male connection with lanyard cap to suit standard refrigerant hose.

DISCHARGE CONNECTION – 1/4" SAE male connection with lanyard cap to suit standard refrigerant hose.

OIL OUT CONNECTION – Situated under the base at the front of the unit is a knurled brass cap on a 1/4" SAE male hose connection.

CARRYING HANDLE – Positioned on the centre of balance on top of the unit.

CABLE WINDER – Positioned on the handle enables stowage for the mains lead.

VENT SLOTS- Situated either side at the front of the unit to enable a ventilating airflow distribution through the unit.

Rear View

CONDENSER FAN – Discharges warm air at the rear of the unit.

VENTILATION FAN – Provides additional airflow through the unit to prevent build up of flammable gas in the event of a leak or accidental discharge.

HARD WIRED MAINS LEAD – 16ft (5m), 14AWG (2.5mm²) heavy-duty lead with moulded plug to power the unit outside of the working area.

RUBBER FEET – Eliminate vibration when the unit is running.

EQUIPMENT NAMEPLATE- Gives details of Serial No. together with refrigerants, design pressures and electrical details.

ELECTRICAL TEST LABEL- Gives date of portable appliance electrical safety test and when next test due.

VOLTAGE LABEL- Identifies the electrical supply for the unit.

CHAPTER 2

OPERATION

Refrigerant Recovery - Pass Through Method

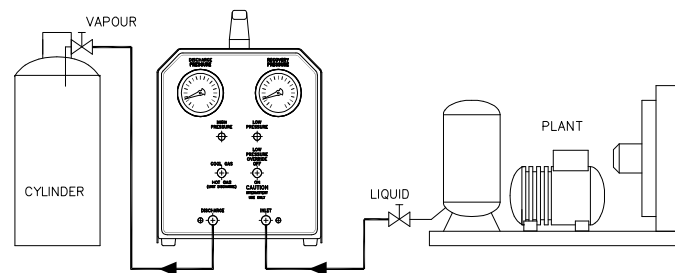

This method of recovery uses the unit to pull the refrigerant from the plant and discharge it direct to a suitable recovery cylinder. This method is best suited to applications where up to 6.6 lbs (3kg) of refrigerant is to be recovered.

- Use a manifold gauge set to connect to both high and low sides of the plant. If possible connect to the plant on the high side at a point where the refrigerant will be in liquid form. Connect the centre hose to the unit inlet.
- Connect the discharge of the unit to a suitable recovery cylinder. Ensure that the recovery cylinder has sufficient free volume to accept the refrigerant you are going to recover and is controlled by a float switch or weigh scale.
- Connect the cylinder float switch or 'Tare' the scale
- Open the valves at the plant and cylinder.
- Set the selector switch to Coolgas.
- Switch the Unit ON.

The unit will start to recover refrigerant. You will hear the *CARESAVER* click as it takes some refrigerant onboard. When the entire liquid refrigerant has been recovered the clicking will stop and the pressure on the unit gauge will begin to fall. When the pressure reaches 0 psi (0 Bar) the unit compressor will automatically stop.

- Switch the unit OFF
- Close all valves and disconnect hoses.
- On applications using piercing pliers, switch the LP override ON and allow the unit to run for 3 minutes maximum to complete the recovery.

Refrigerant Recovery - Push - Pull Method

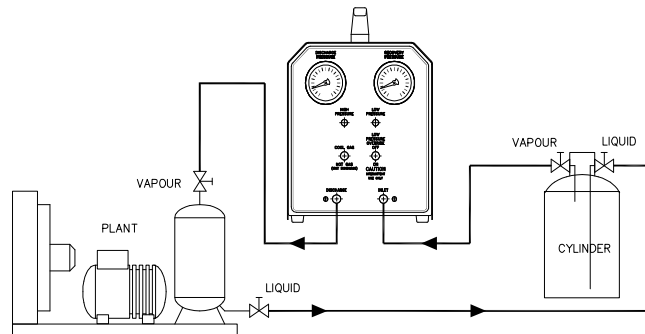

This method of recovery uses the unit to pressurize the refrigerant in the plant so that it can be discharged directly to a suitable recovery cylinder. This method is best suited to applications where more than 6.6 lbs (3kg) of refrigerant is to be recovered.

- Connect the inlet connection of the unit to the vapour port of a suitable twin ported recovery cylinder.
- Connect the discharge of the unit to a suitable point on the plant where the refrigerant will be in vapour form.
- Connect a hose from a liquid port on the plant to the liquid connection on the recovery cylinder. Ensure that the recovery cylinder has sufficient free volume to accept the refrigerant you are going to recover and is controlled by a float switch or weigh scale.
- Connect the cylinder float switch or 'Tare' the scale
- Open the valves at the plant and cylinder.
- Switch the unit ON.
- Set the selector switch to Hotgas.

The unit will start to recover refrigerant from the cylinder, which will reduce the pressure within the cylinder. At the same time the unit will discharge into the plant which will raise the pressure. The pressure difference between the plant and the cylinder will result in refrigerant transfer.

When the bulk of the refrigerant has been recovered, reconfigure the set up to the Pass Through method to remove the remaining refrigerant vapour.

Hints and Tips

To provide maximum protection to the unit it is recommended to fit a filter in the suction line during operation.

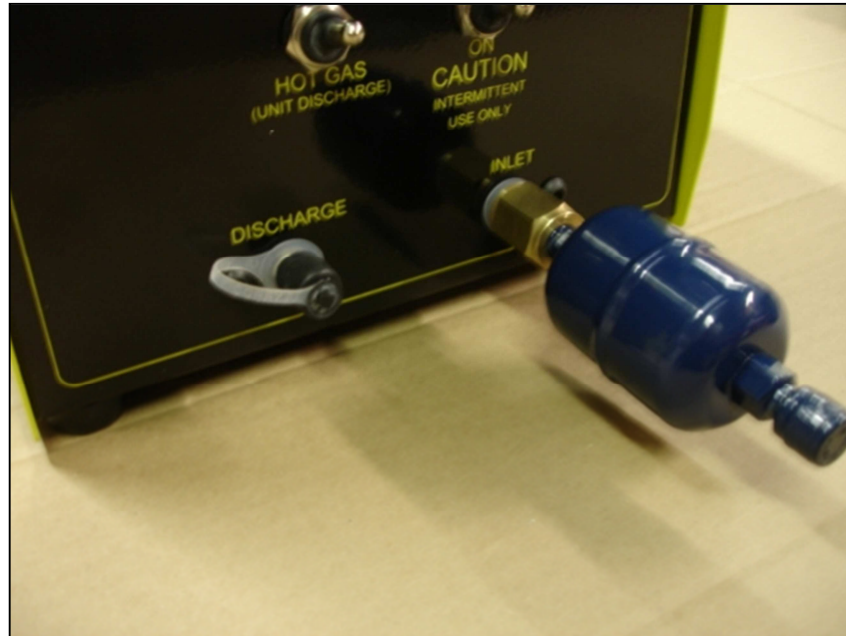

Typical Filter fitted to unit Inlet

Using hoses with integral shut off valves will enable the unit to be disconnected from the cylinder without venting the contents of the hose to atmosphere. Use a 3/8" hose, with and adaptor if necessary, to speed up recovery time.

It is recommended that the valve depressors are removed from hoses if not required. Vacuum certified valve core removal tools are available for connection to the plant. Check the hose gaskets for wear and deformation that can cause a restriction to flow.

Always remove liquid from the high side of the plant first then recover vapour from both high and low sides. This will shorten the recovery process.

Avoid the use of extension cables if possible as this will lower the voltage at the unit and reduce the performance of the unit and can cause overheating.

Always transport the unit in an upright position.



Every effort has been made to make the unit as easy and safe to operate as possible but operators should always follow these safety precautions:

- Always wear appropriate eye protection, clothing and gloves when handling refrigerant.
- Only a trained operator should handle refrigerants. Engineers working with HC refrigerants should be trained on HC refrigerant handling and equipment.
- Never overfill a cylinder. Weigh the recovery cylinder and fill to only 60% of the volume with liquid to leave room for expansion.
- If a compressor burn-out is suspected on the appliance carry out a refrigerant test for acid. If recovery is still to be undertaken fit a burn out filter in the hose line during recovery.
- Make sure that the plant is switched off before attempting to recover refrigerant.
- Do not leave the unit unattended whilst recovery is in progress.
- When recovering HC refrigerants the area must be well ventilated.
- There must be no ignition source within 3m of the work and the area must be monitored with a hydrocarbon detector.
- Use a separate recovery cylinder dedicated for each type of refrigerant and have an extra cylinder for unknown refrigerants and refrigerant recovered from compressor burn-outs.

CHAPTER 3

MAINTENANCE

It will be necessary to discharge the residual refrigerant between jobs, to avoid any mixing.

Connect the discharge to a recovery cylinder with a ball valve hose and set the selector switch to Hotgas/Self discharge. Open the cylinder and ball valves on the discharge hose, set the LP override switch ON and briefly run the unit. Close the valves and disconnect the unit.

The unit uses a combined heat exchanger/oil separator during the recovery process. Waste oil from recovered liquid should periodically be drained, with the unit switched off and at zero gauge, via the removable cap situated under the unit.

Dispose of waste oil safely.



Drain waste oil from underneath the

CHAPTER 4

TROUBLESHOOTING

This chapter helps the operator to identify and rectify most of the common problems encountered when using the Caresaver unit.

Unit does not start

Mains cable plugged into faulty socket outlet	Try another socket
LP lamp illuminated	Check inlet pressure on gauge is above 17 psi (1.2bar)
HP lamp illuminated	Check discharge hose ball valve and recovery cylinder valve are open
Cylinder sensor is detecting full	Check sensor and weight of tank Change cylinder
Thermal trip	Allow unit to cool down

Recovery slows down

Oil separator needs draining	Drain oil from recovered liquid as Chapter 3
Plant approaching vacuum	As the pressure in the plant decreases so does the density of the refrigerant vapour being recovered, hence the mass flow decreases proportionally
Restriction to flow	Check hose schraeder depressors have been removed
Trapped liquid	If pressure remains in system momentarily start the plant

High Pressure Trip

Valve on discharge line closed	Check hose valves and cylinder valve
Blockage	Check for worn hose gasket
Cylinder full and overpressure	Check float switch for failure

CHAPTER 5

APPENDICES

1. Piping and Instrumentation Diagram
2. Electrical Circuit Drawings
3. Spare Parts list

1. Piping and Instrumentation Diagram

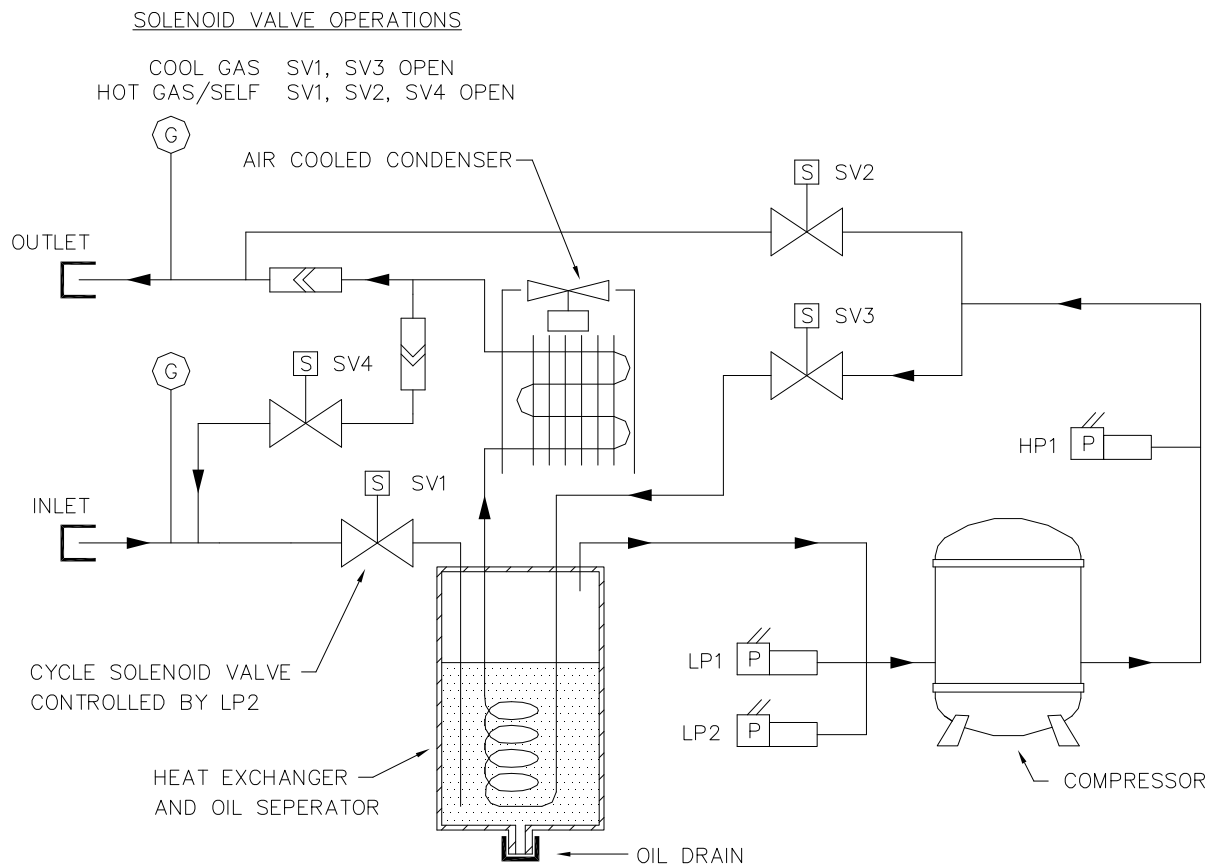

2. Electrical Circuit Schematic

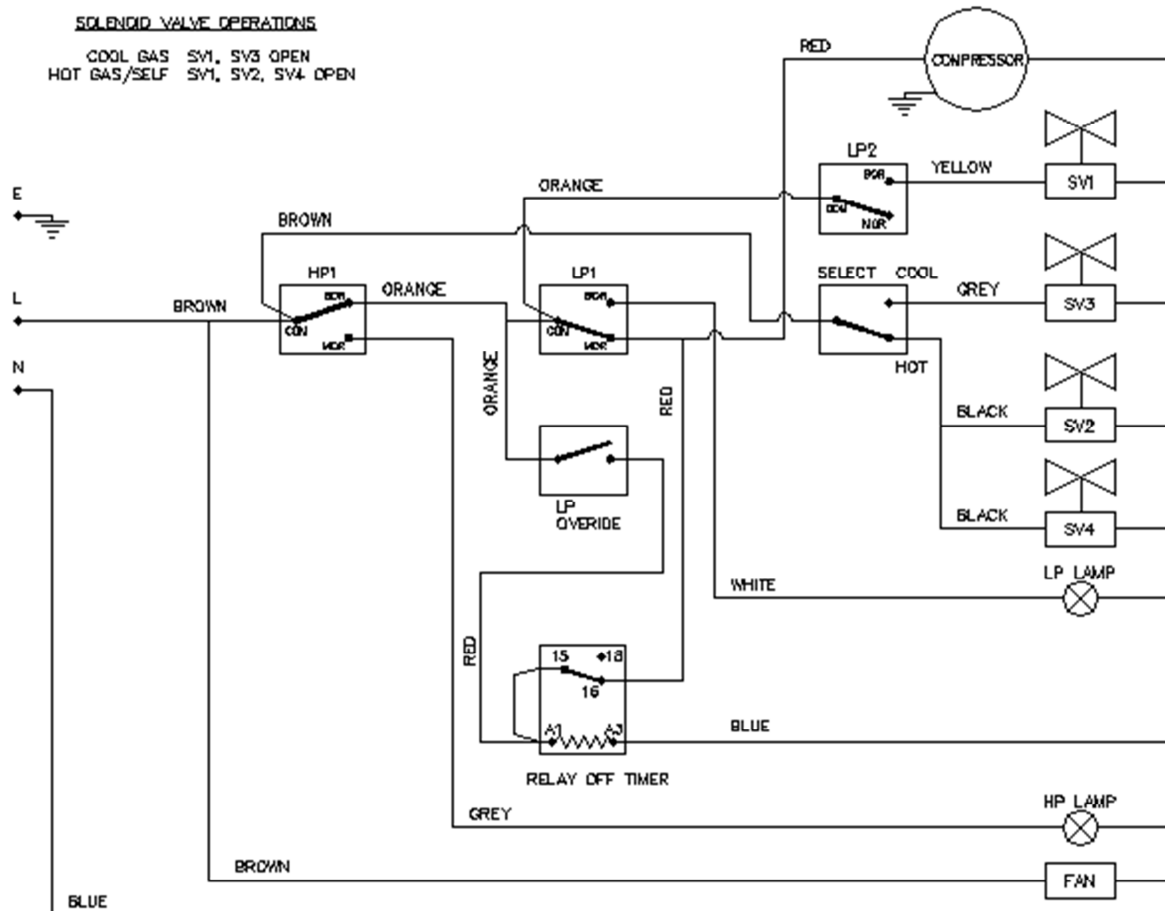

3. Spare Parts List

Part Number	Description
X2899-1001	Compressor
X2899-1002	Solenoid Valve
X2899-1003	Pressure Switch LP
X2899-1004	Pressure Switch Cycling
X2899-1005	Pressure Switch HP
X2899-1006	Power Lead 5m
X2899-1007	Pressure Gauge
X2899-1008	Condenser Coil
X2899-1009	Fan
X2899-1010	Check Valve
X2899-1011	Handle
X2899-1012	Cover
X2899-1013	Lamp
X2899-1014	Switch LP Override
X2899-1015	Switch Hot Gas/ Cool Gas
X2899-1016	Refrigerant Hose
X2899-1017	Cylinder Float Switch Cable
X2899-1018	Inline Filter